

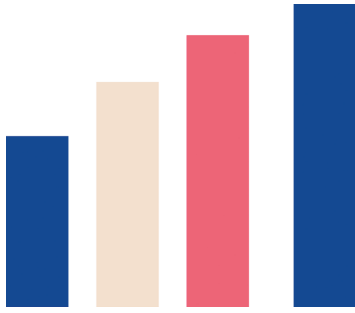

Good
Money
Guide

the London
INVESTOR
show



THE GOOD MONEY GUIDE LONDON INVESTOR SHOW 2024

EXHIBITOR BROCHURE

Event Date: Friday 1st November 2024

Venue: Champagne Suite, 1st Floor,
Novotel London West, W6 8DR

Doors open: 9.30 am **Doors close:** 5.00 pm

**A one-day exhibition and event for private investors,
traders and active market participants**

- Meet and speak with up to **3000+** private investors
- Collect valuable data for follow-up after the event
- Network with other industry participants, make new contacts
- Increase market share

Media partners:

MONEYWEEK

Supporters:



MORNINGSTAR Indexes



Organised by:



www.londoninvestorshow.com

Introduction and Welcome

Welcome to the London Investor Show - a unique, one-day exhibition and event dedicated to providing education and information to private investors and traders in the UK.



The Good Money Guide London Investor Show is the definitive UK investor event, covering all areas of stock market investment, appealing both to novice investors who are starting out, as well as more sophisticated, active investors.

NEW feature for 2024 - The Wealth Clinic

In addition to investment training workshops, panel sessions discussing various topics of interest for investors, and free seminars taking place throughout the day, delegates will be invited to drop into the "Wealth Clinic". The Wealth Clinic offers a confidential service to investors - a chance to ask questions in private, and find out where to go for advice tailor-made for them. Appointments will be available to book online in advance.



The London Investor Show and Sustain.Social 2023

The Good Money Guide London Investor Show

The stockmarket under one roof.



A delegate uses the self-badge terminal option at Registration. Staffed Registration desks are also available.



Delegates watching a seminar at the London Investor Show



Delegates at the London Investor Show

Why Exhibit?

As an exhibitor at the Good Money Guide London Investor Show, you and your company have access to a niche audience of engaged and interested delegates - up to 5000 investors and traders are expected to attend over the one day.

These delegates are ready to learn, ready to meet the product and service providers they need to help them achieve their financial and investment goals. They are also keen to meet new investment opportunities in all sectors.

Choose to be part of the UK's premier educational event for investors and traders and

- meet and speak to potential clients, face-to-face
- create goodwill and positive branding amongst retail investors and traders - encouraging interaction and new business.
- collect leads and valuable market research - important data for post-event sales and event follow-up.
- launch new products and services to an interested and engaged audience of investors.

"The Good Money Guide London Investor Show offers a unique opportunity for delegates - to learn about investing, trading and the financial markets in general.

Bringing together leading brokers, analysts, trading experts, commentators and academics in one informative and high energy forum. It's always an exciting day!

I look forward to meeting you there."

**Lisa Campbell, Managing Director
Investor Conferences (UK) Ltd
(Organisers of the London Investor Show)**

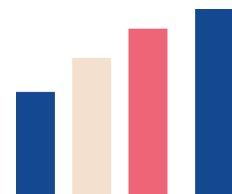

What previous delegates say about the London Investor Show...

"Spending a day at the London Investor Show was a very useful experience. The exhibitors were a very good selection of people, who I needed to see. There was a very lively set of different speakers, who were exciting and talented.

"The layout of the exhibition stands was very well thought out, and the wide corridors between stands encouraged 'timely in the corridor' conversations. I plan to attend future Shows and to attain great value from doing so."

*With best regards and best wishes
Barry H. Massey (Prof.Dr.)*

"Just a short note to thank you and your team for putting on an excellent event last week. I was delighted with the way it turned out and was very pleased with the interest levels for India. Please do let us know of future events that might be appropriate for us to attend.

With thanks again
David

(David Cornell, Managing Director, Ocean Dial Asset Management)

"Just a quick note to say how great it was to be out and about again at your show on Friday meeting investors. A big thank you and the rest of the team for creating another superb investor event."

Best wishes, Mike (and the rest of the ShareSoc/SIGnet team)"



Why will Delegates Attend?

The Good Money Guide London Investor Show provides delegates with an exciting and vibrant live forum, where they can spend a day learning new investment and trading skills, collecting information, hearing the views of the panel members and meeting exhibitors who have the products and services that could help them become successful investors and traders.

It is also an excellent opportunity for investors to meet one another, swapping ideas and experiences, making new contacts and feeling very much part of the retail investment community. Ultimately, delegates attend because they value the event, the knowledge and experience they gain by spending time at the Good Money Guide London Investor Show, which they use to build and implement, creating a profitable and successful investment portfolio

What's on for Delegates

The Good Money Guide London Investor Show is a “must-attend” event for private investors and traders, offering a day packed with stimulating sessions, live events, investment workshops and free seminars, plus the chance to meet and speak to some of our most highly-regarded investment experts in the UK.

- **KeyNote Speech** - an opportunity for sponsors to welcome delegates to the London Investor Show 2024.
- **Meet the Company** - Meet the Company in association with  **EDISON** Where investors can hear company presentations from a selection of exciting UK growth prospects
- **FREE Seminars** throughout the day.
- **The OpenStage Theatre** - where live seminars and talks take place throughout the day, open for all delegates to the London Investor Show.
- **The Investors' Networking Lunch** - a chance for delegates to meet one another over lunch, at tables hosted by exhibitors and speakers.
- **LIVE Panel Sessions** on a variety of current issues of importance to private investors.
- **The Investment Trust Forum** (in association with Research in Finance) - a dedicated 2-hour conference where investors can hear from leading investment trust fund managers, who will share their insights on the most exciting sectors for 2025 on the global stage.
- **LIVE Lunchtime Summit** This year, the panel discuss, “What can the UK's new government do to best help investors?” - with Holly Mead, Deputy Money Editor, The Times and Sunday Times; Neil Blankstone, Head of Trading, GHC Capital Markets; Craig Rickman, Personal Finance Editor, interactive investor and Toby Finden-Crofts, Research in Finance.
- **The Wealth Clinic** - a drop-in zone for investors seeking an opportunity to discuss their current portfolio, and find out where to go for personalised advice
- **Investment Exhibition** featuring stockbrokers, wealth managers, information providers, software providers, fund managers, as well as new investment opportunities
- **Speakers Corner** where authors and other presenters host short talks for delegates.

Current and Previous Speakers Include...



Justin Urquhart Stewart
Co-Founder and Director, Regionally



Dan Jones
Deputy Editor, Investors' Chronicle



Gerald Perez
Interactive Brokers (U.K.) Limited



Alpesh Patel, OBE
Market Commentator,
Investment Author
www.alpeshpatel.com



Rodney Hobson
Fundamental Investor and
Investment Author



Richard Hargreaves
Early-stage technology investor



Gareth Parker
Morningstar Indexes



Gavin Oldham
Share plc Share Radio



Nicola Horlick



Richard Stone
Chief Executive, Association of
Investment Companies



Tom Stevenson
Fidelity



Craig Rickman
interactive investor



Moira O'Neill
interactive investor



Ben Constable-Maxwell
M&G Investments

Delegate Statistics 2023

As delegates registered online to attend the London Investor Show last year, they were asked to please complete some questions. These questions help provide insight into who the delegates are, ensuring that the London Investor Show matches the right audience to the right exhibitors. We are pleased to share the results with you below.

What is the current valuation of your portfolio?

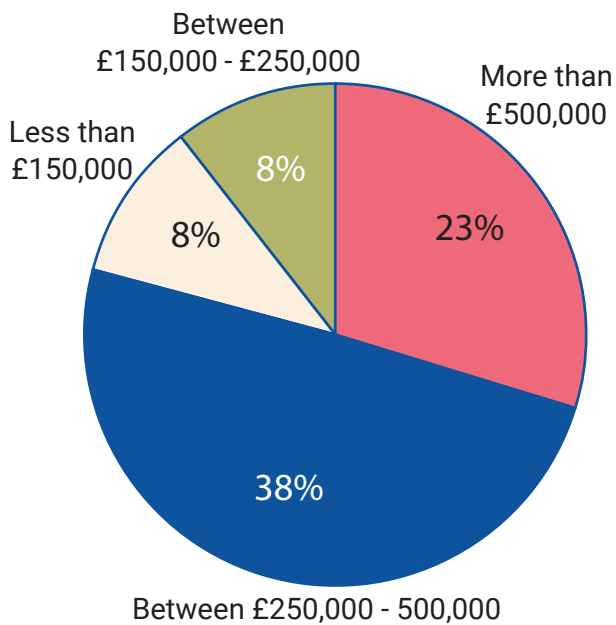

Are you...

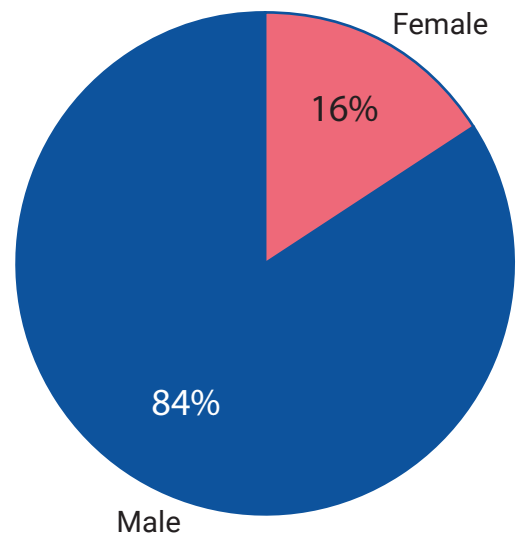

What age bracket do you fall into?

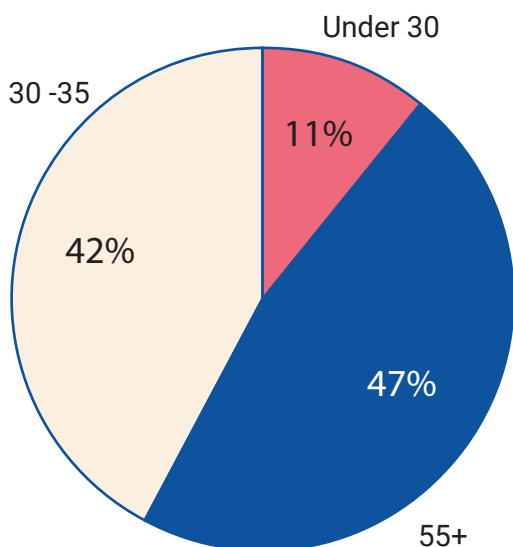

Do you intend to invest more, or less, over the next 12 months? (Oct 2023 - Oct 2024)

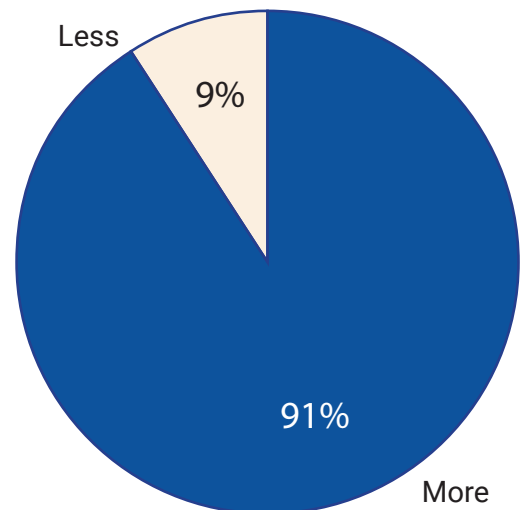

..... and taking place on the same day, in the same venue as the London Investor Show



Sponsored by:  **M&G**
Investments

THE SUSTAINABLE & SOCIAL INVESTING CONFERENCE

(Sustain.Social)

Taking place on the same day, in the same venue as the London Investor Show, this sister event from Investor Conferences is sponsored by M&G Investments and is dedicated to sustainable and social investing.

The Conference invites delegates interested in sustainable investing to hear from a wide range of highly-respected speakers in this area.

Covering sustainability, greenwashing, the future of ESG and how to choose stocks that align with individual standards.



DELEGATE STATISTICS

SUSTAIN.SOCIAL

PLEASE SEE THE HIGHLIGHTS OF RECENT DELEGATE RESEARCH BELOW:

33% manage a portfolio worth **more than £500,000**

11% manage a portfolio worth between **£250,00 and £500,000**

43% are under 55 years of age, with **11% younger than 30**

22% are new to investing and attending the event in order to learn, and to meet the companies that can help them set up and run their own investment portfolios

FLOORPLAN

Venue: Novotel London West
Date: Friday, 1st November 2024

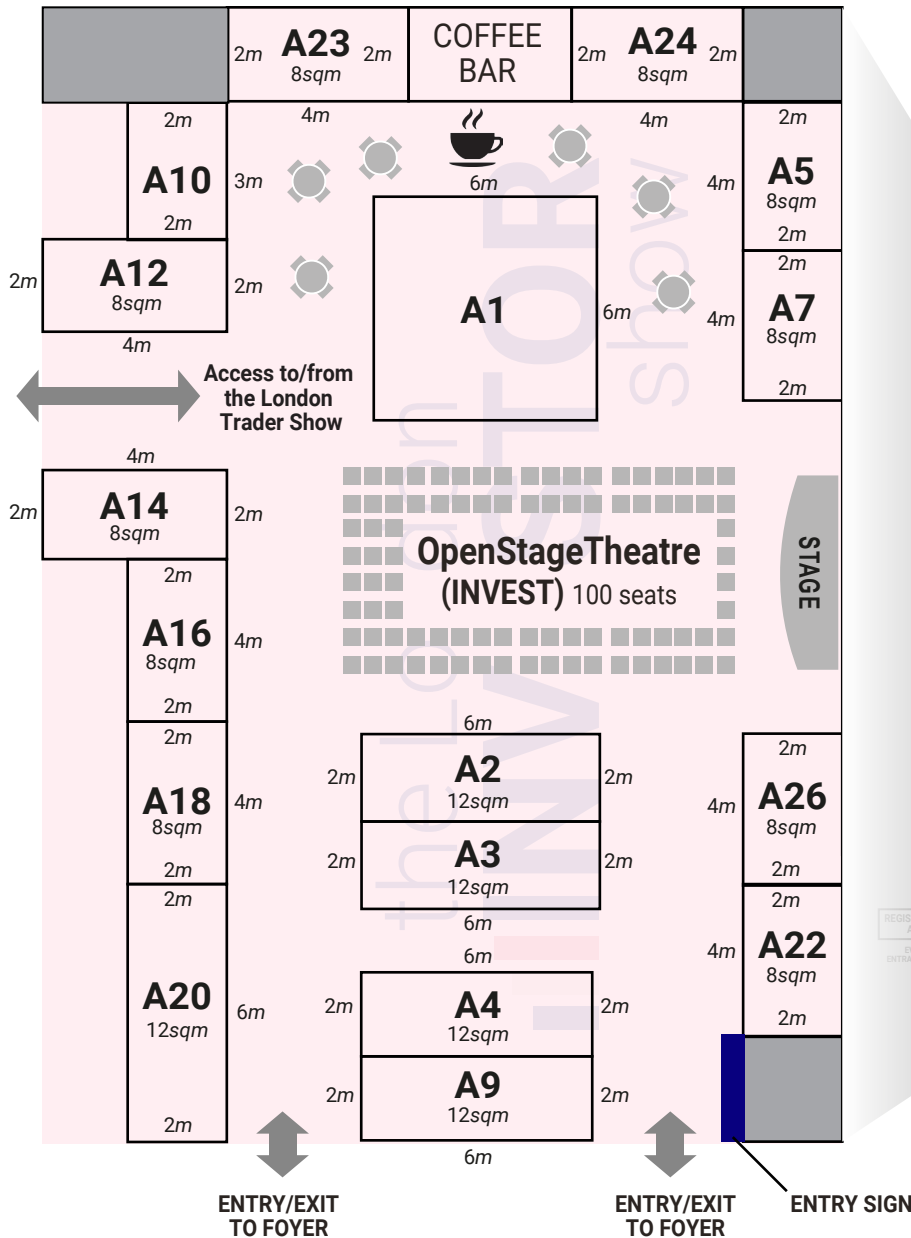
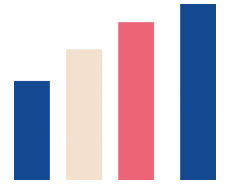

EVENT DETAILS:

Friday, 1st November 2024
Champagne Suite, Novotel London West,
London W6 8DR
Doors Open: 9.30 am
Doors Close: 5.00 pm
For further information,
please contact:
Lisa Campbell 0131 618 2131
lisa@londoninvestorshow.com

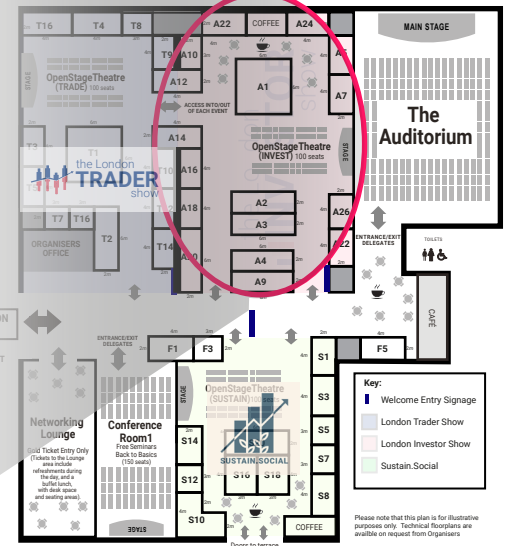



THE GOOD MONEY GUIDE LONDON INVESTOR SHOW 2024

Champagne Suite, Novotel London West

Friday, 1st November 2024

Doors open: **9.30 am**

Doors close: **5.00 pm**

For further information, please contact:

Lisa Campbell

Mobile: 07504 237902

Office: 0131 618 2131

Email: lisa.campbell@investorconferences.co.uk

"MoneyWeek has always prided itself on providing investors with information they can profit from. The London Investor Show offers an unparalleled array of ideas and expertise to help them accumulate and protect their wealth. We are therefore delighted to enter into a media partnership with the event'.

Andrew VanSickle - Editor 

Media partners:



Supporters:



Organised by:



InvestorConferences

www.londoninvestorshow.com